

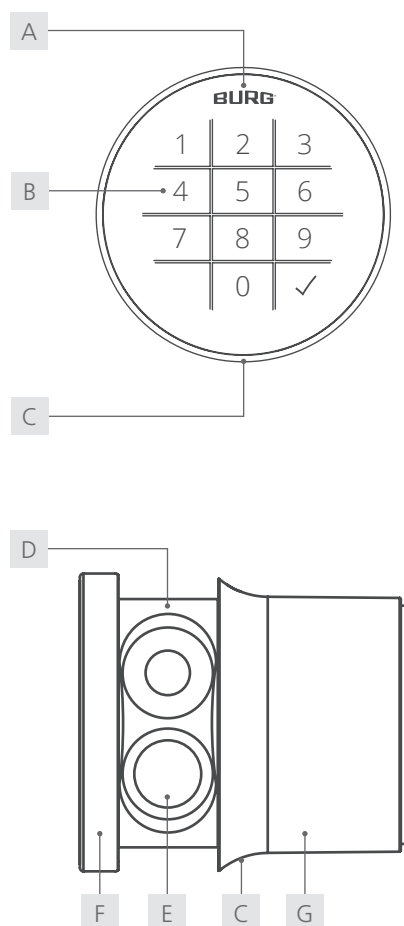

Flexo.Code Operating Manual

Flexo.Code



- A LED
- B touchpad keys
- C closure hole
- D battery compartment
- E battery
- F knob
- G housing

Content

| | |
|--------------------------------|---|
| Introduction..... | 2 |
| General..... | 2 |
| Technical data..... | 3 |
| Scope of delivery..... | 3 |
| Optional accessories..... | 3 |
| Default settings..... | 3 |
| Features..... | 3 |
| Product dimensions..... | 3 |
| Functional description..... | 4 |
| Assembly flush fit..... | 5 |
| Assembly retro fit..... | 6 |
| Configuration..... | 7 |
| Operation..... | 8 |
| Battery replacement..... | 8 |
| Disposal and battery note..... | 8 |

Introduction

The **Flexo.Code** impresses with its versatile application and installation options. The innovative design lock offers the possibility of individual time control with adjustable closure duration and up to 999,999 code variants.

Like all locks in the Flexo range, the code variant allows both recessed installation (flush fit) and retrofitting (retro fit). Thanks to the possible one-, two- or three-point locking with latch function, it adapts conveniently to any installation situation.

Important: Please observe all warnings and read through the entire operating instructions before you begin with the configuration.

General

The latest version of this guide is available at:
www.burg.de

Factsheet

Front view



Back view

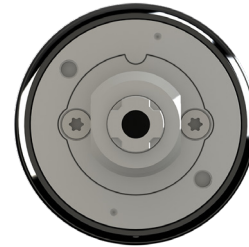

Technical Data

| | |
|-----------------------------|---|
| Dimension | Ø 50 mm |
| Battery | VARTA ¹ 1/2 AA (2x) |
| Locking cycles ¹ | 30,000 |
| Working temperature | -20° C to 55° C rel. humidity: 10% - 85% |
| No. of code combinations | 999,999 |
| Code length | 4 or 6 digits |
| Mode | Multi User Mode, Private Mode |
| Material | Housing: plastic Cam: steel |
| Mounting dimension | 16 mm x 19 mm |
| Locking direction | Left (90°), door hinge: DIN right |
| Lock attachment | M19 nut (1x) |
| Cam type | B |
| Max. door thickness | 22 mm |

Optional Accessories

- anti-twist protection (W-MSZ-01)
- opening pin
- Flexo.Ring + fixing nut

Default Settings

| | |
|------------------------|-----------------|
| Master Code | 934716 |
| Mode | Multi User Mode |
| Code length | 4 digits |
| Locking | Manually |
| LED locking indication | On |
| Code confirmation | Off |

Features

- ergonomic handling and high-quality design
- external battery access and battery replacement
- time-controlled unlocking and locking
- easy to retrofit, e.g. for replacement of mechanical locks
- adjustable cam (in 90° steps)

Scope of Delivery

- 1x locking system
- 1x cam fixing screw² M6 x 12 mm
- 1x M19 nut
- cam type B

for single packaging:

1x length 53 mm, without crank (1-36 RIH-501 G)

1x length 40 mm, crank 3 mm (1-36 RIH-514 K)

1x length 40 mm, cranking 6 mm (1-36 RIH-515 K)

for industry packaging: order related

Product Dimensions

Front view

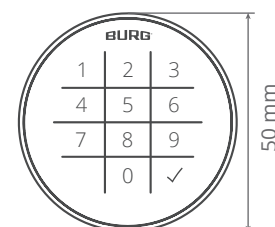

Side view

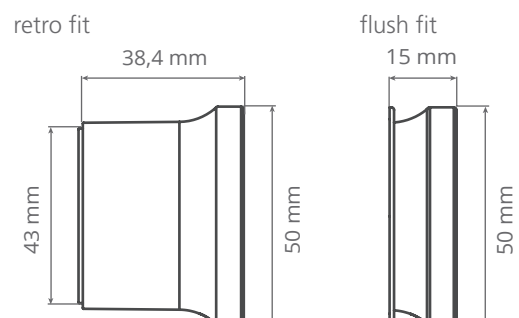

¹ The lock is approved for VARTA brand batteries. The use of other batteries may result in a reduced number of possible locking cycles.

² The use of a screw with a different length may cause damage to the lock.

Functional Description

Mode: Fixed Assigned Authorization (Private Mode)

In this mode, a code is pre-set with which the lock can be operated. This mode is suitable for user groups where user rights do not have to change permanently, e.g. in an office cabinet. To close, the user enters a stored code. The lock is opened by entering this or another stored code. Up to 50 codes can be stored. A code that has not been stored is rejected by the lock.

Mode: Multi User Authorization (Multi User Mode)

This mode is suitable for constantly changing users who only use the compartment temporarily or once, e.g. in a sports facility. Codes are valid for a single locking process and are deleted by the lock when the compartment is reopened so that a new code can be used. The locking bolt remains open until a new code locks the lock again. Before locking, the door must be closed (slightly pressed). The user enters a code of choice (4 or 6 digits) to close. The green LED starts flashing. The lock is opened by entering the same code.

Code Confirmation (Multi User Mode)

To lock the lock, the code must be entered twice. The lock only locks after the second entry. The second entry is made after the green LED flashes briefly. A simple code entry is sufficient to open the lock. This function can be turned on or off.

Master Code

The Master Code authorizes the programming of the lock. In addition, the Master Code can unlock the lock independently of the set mode (emergency opening) and terminate the block mode. In Multi User Mode, the code used for locking is deleted after the Master Code is entered.

Note: We recommend programming a private Master Code before putting the lock into operation.

LED Locking Indication

The lock indicates the locked state by flashing the red LED every second. This function can be turned on or off.

Automatic Locking (Private Mode)

The lock locks automatically after three seconds after unlocking. The door does not have to be closed for this. The latch function allows the door to be closed by pressing slightly even with the lock locked. This function can be turned on or off.

Battery Warning

If the battery capacity falls below a certain limit, the red LED lights up for three seconds after the code has been entered. If the critical level is reached, the lock can no longer be locked or can only be opened with the Master Code.

Note: We recommend changing the battery already after the first warning.

Block Mode

After three consecutive failed opening attempts, the lock locks for 45 seconds. During this period, no action is possible on the lock. The locking time is indicated by the red LED flashing every second. The locking mode can be cancelled by entering the Master Code.

Functional Description RTC

The Flexo.Code also has an integrated software real-time clock (RTC) that can be used to program time-related functions. The functions and the defined times must be specified when ordering.

Automatic Locking / Unlocking at a certain time

The lock locks and unlocks automatically at a defined time. The times can be set separately for each day of the week. Programming is carried out by BURG.

Time Window Usage

The lock can only be operated within the individually defined time-of-use period. The lock cannot be operated outside this period. The times can be set separately for each day of the week. Programming is carried out by BURG.

Closure Duration

The closure duration defines the maximum period for which a lock may be locked from the time of locking. After expiry of the locking period, the lock opens automatically. Programming is carried out by BURG.

Assembly Flush Fit

- 1 Prepare the installation hole on the door front according to the installation dimensions described below.

Note: If you require a template (step file) for milling, punching or laser cutting, please contact your BURG representative.

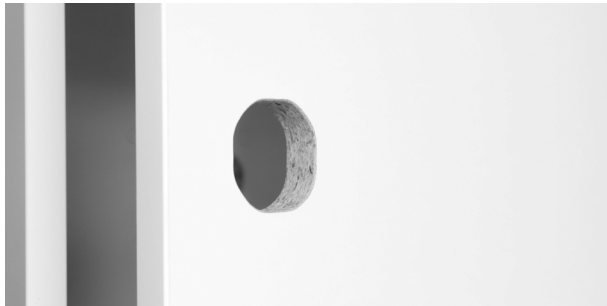

- 2 From the front, insert the Flexo.ring into the installation hole on the outside of the door and hold it in this position. Check whether the Flexo.ring is fully seated on the outside of the door. Make sure that the mounting hole on the inside is in the correct position. Screw the fastening nut to the Flexo.ring from behind. Tighten the nut hand-tight.

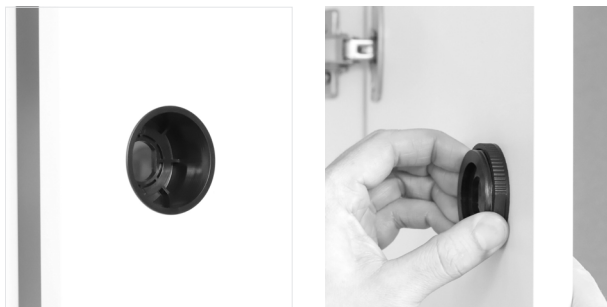

- 3 Insert the lock body from the outside of the door into the opening of the Flexo.Ring. Make sure that the BURG logo on the front of the knob is at the top.

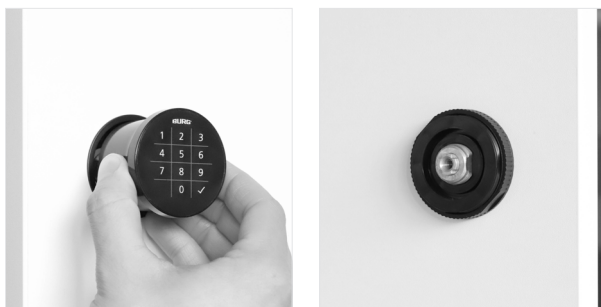

- 4 Place the fastening nut on the lock from behind. Tighten the nut with a socket wrench (SW22).



- 5 Place the latch and fasten it with the Torx screw (Torx 30) provided.

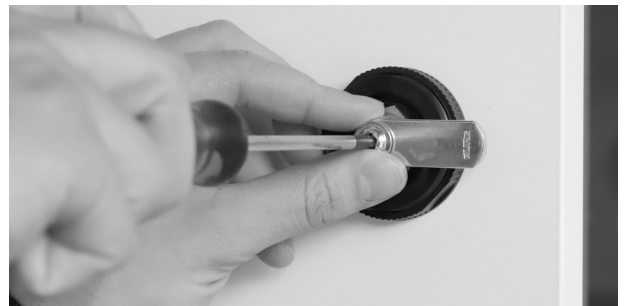

- 6 Then check whether the deadbolt gets sufficient hold on the strike plate or the rebate when closed. The latch should be able to be turned to its end position without pressure or resistance when the locking system is closed.



Mounting dimensions

The dimensions for the installation hole on the outside of the door applies to installation in fronts made of wood, HPL and steel.

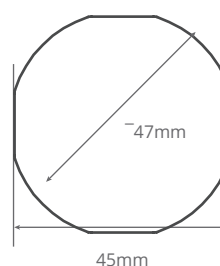

Note: The adjacent drawings are not to scale and are not suitable as a template for milling. For a template (step file), please contact your contact person at BURG.

Assembly Retro Fit

- 1 Prepare the installation hole on the door front according to the installation dimensions described below. Note that an adapted two-stage recess may have to be milled for fronts made of wood and MDF. This recess is not required for metal fronts.

Note: If you require a template (step file) for milling, punching or laser cutting, please contact your BURG representative.

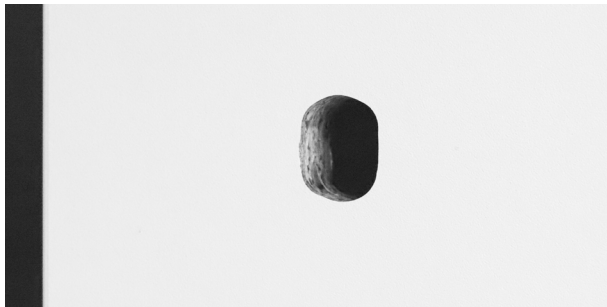

- 2 Insert the lock body into the installation hole from the outside of the door. Make sure that the BURG logo on the front of the knob is at the top.



- 3 Place the fastening nut on the lock from behind. Tighten the nut with a socket wrench (SW22).



- 4 Place the cam and fasten it with the Torx screw (Torx 30) provided.



- 5 Then check whether the deadbolt gets sufficient hold on the strike plate or the rebate when closed. The latch should be able to be turned to its end position without pressure or resistance when the locking system is closed.

Note: Closing can be optimally adjusted by means of an adaptable striking plate. For more information, please get in touch with your contact at BURG.

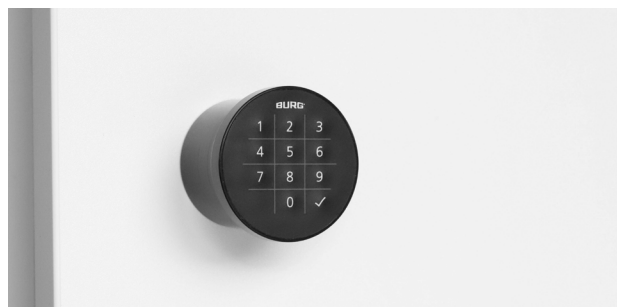

Mounting dimensions

The dimensions for the installation hole on the outside of the door applies to installation in fronts made of wood, HPL and steel.

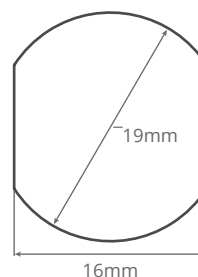

Note: The adjacent drawings are not to scale and are not suitable as a template for milling. For a template (step file), please contact your contact person at BURG.

Configuration

Observe the following notes before you start the configuration:

- Each configuration step is started by pressing the hook key twice and the corresponding digit.
- Each configuration step is completed with the green LED flashing twice.
- The next configuration step can only be started after the the green LED flashes twice.
- If the red LED flashes 8 times in quick succession, the configuration step was not carried out correctly.

1 Mode Selection

a) Private Mode

| | |
|-------------------|--------------------|
| Enter Master Code | ✓✓ 1 Master Code ✓ |
| Set mode | ✓✓ 5 0 ✓ |

Note: To assign the private codes, please go to point 3a „Set the code“.

b) Multi User Mode (default)

| | |
|-------------------|--------------------|
| Enter Master Code | ✓✓ 1 Master Code ✓ |
| Set mode | ✓✓ 5 1 ✓ |

Note: After changing the mode, all functions are reset to the default settings. This does not apply to the Master Code.

2 Set Code Length

| | |
|-------------------------|--------------------|
| Enter Master Code | ✓✓ 1 Master Code ✓ |
| Select number of digits | ✓✓ 0 x ✓ |
| | 4 digits: x = 4 |
| | 6 digits: x = 6 |

Note: After changing the number of digits, all codes stored in Private Mode are deleted.

3 Set Functions

a) Configuration in Private Mode

Set code

| | |
|-------------------|--------------------|
| Enter Master Code | ✓✓ 1 Master Code ✓ |
| Set code | ✓✓ 3 xxxx (xx) ✓ |

Note: Up to 50 private codes can be stored. Depending on the set code length, these must be 4 or 6 digits long..

Delete the code

| | |
|-------------------|--------------------|
| Enter Master Code | ✓✓ 1 Master Code ✓ |
| Delete code | ✓✓ 9 xxxx (xx) ✓ |

Note: Enter the code you want to delete.

Automatic locking

| | |
|-------------------|--------------------|
| Enter Master Code | ✓✓ 1 Master Code ✓ |
| Activate | ✓✓ 6 1 ✓ |
| Deactivate | ✓✓ 6 0 ✓ |

b) Configuration in Multi User Mode

Code confirmation

| | |
|-------------------|--------------------|
| Enter Master Code | ✓✓ 1 Master Code ✓ |
| Activate | ✓✓ 2 1 ✓ |
| Deactivate | ✓✓ 2 0 ✓ |

c) Set General Functions

Set private Master Code

| | |
|---------------------------|--------------------|
| Enter current Master Code | ✓✓ 1 Master Code ✓ |
| Enter new Master Code | ✓✓ 7 xxx xxx ✓ |

Note: The Master Code must be 6 digits long.

LED locking indication

| | |
|-------------------|--------------------|
| Enter Master Code | ✓✓ 1 Master Code ✓ |
| Activate | ✓✓ 8 1 ✓ |
| Deactivate | ✓✓ 8 0 ✓ |

Operation

1 Operation in Private Mode

| | |
|--------|------------|
| Lock | enter code |
| Unlock | enter code |

2 Operation in Multi User Mode

| | |
|--------|------------|
| Lock | enter code |
| Unlock | enter code |

Note: If the code confirmation is set, the code must be entered twice when locking.

Entry the Master Code

The Master Code can unlock the lock, authorizes the configuration or terminate the block mode regardless of the set mode. Observe the following note when entering the Master Code:

Always start entering the Master Code by pressing the **hook key twice** and the **digit 1**.

Enter Master Code ✓✓ **1** Master Code ✓

Note: In Multi User Mode, the code used for locking is deleted after entering the Master Code.

Battery Replacement

1. Push the opening pin into the closure hole at the bottom of the lock. Move the pin slightly counterclockwise and pull the knob forward.

2. Open the battery cover and replace the batteries. Insert the new batteries according to the symbols (+ / -).

Note: The surface of the batteries must be free of residues and fingerprints, otherwise malfunctions may occur. If the surface is dirty, it must be cleaned with a dry cloth.

3. Close the battery cover, push the knob back onto the lock and turn the housing back until it locks into place.

Note: The lock is approved for VARTA brand batteries. The use of other batteries may result in a reduced number of possible locking cycles.

Disposal and Battery Note

EU Directive 2012/19/EU regulates the proper take-back, treatment and recycling of used electronic equipment.

Every consumer is required by law to dispose of batteries, accumulators or electrical and electronic equipment („waste equipment“) powered by batteries or accumulators separately from household waste, as they contain harmful substances and valuable resources. Disposal can be done at a collection or take-back point approved for this purpose, e.g. a local recycling center. Waste equipment, batteries or rechargeable batteries are accepted there free of charge and recycled in an environmentally friendly and resource-saving manner.

Waste equipment, used batteries or rechargeable batteries can also be returned to us. The return must be sufficiently stamped to the address below.

The following symbol on the waste electrical equipment, batteries or accumulators indicates that they must not be disposed of with household waste:



Caution when using batteries!

The battery may explode or release flammable gases if it is mishandled, destroyed, or the wrong type of battery is used. Do not recharge the battery, disassemble it, expose it to extremely high temperatures or throw it into a fire.

On batteries containing harmful substances, you will find indications in the form of abbreviations for the ingredients cadmium (Cd), mercury (Hg) and lead (Pb) in each case.

BURG Lüling GmbH & Co. KG

Volmarsteiner Str. 52
58089 Hagen (Germany)
+49(0)2335 6308-0

info@burg.de
www.burg.de